

LED Module Lighting System

Crystal RGB



BEFORE YOU BEGIN

Read these instructions completely and carefully.

Prepare Electrical Wiring

- Acceptable for use in dry, damp and wet locations
- Follow all National Electric Codes (NEC) and local codes.
- This product is intended to be installed and serviced by a qualified, licensed electrician.
- Ensure applicable wire is installed between driver, fixture, and any controls in between.
- When choosing wire, factor in voltage drop, amperage rating, and type (in-wall rated, wet location rated, etc.). Inadequate wire installation could overheat wires, and cause a fire.
- Do not install if product has any visible damage.
- Do not modify or disassemble this product beyond instructions or the warranty will be void.



WARNING

RISK OF ELECTRICAL SHOCK

- Turn power off before inspection, installation or removal.
- Properly ground power supply.

RISK OF FIRE

- Use only UL approved wire for input/output connections
- Minimum wire size 18 AWG
- Follow all NEC and local codes.



Shock Hazard.

May result in serious injury or death.

Turn off power at the circuit breaker before installing this product.

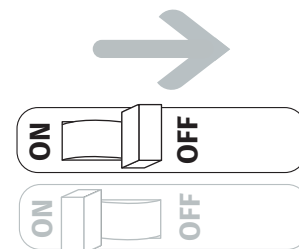

- 1 - UL approved supply wire
- 2 - UL approved twist-on wire connectors or In-line/IDC connectors
- 3 - Screws, rivets, electronic grade silicone or equivalent
- 4 - 12 Volt Power Supply
- 5 - LED Modules

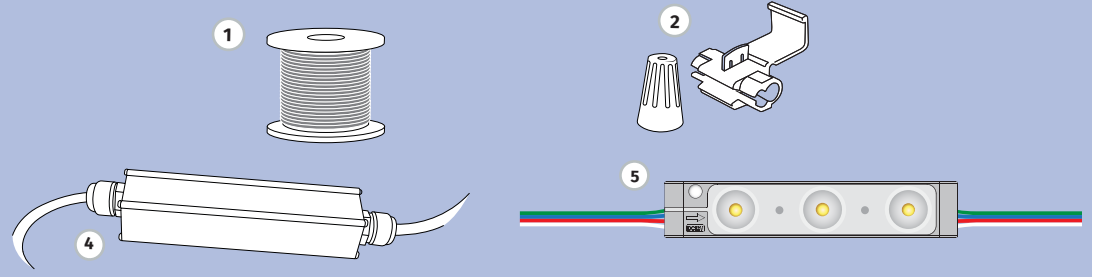

Layout Modules

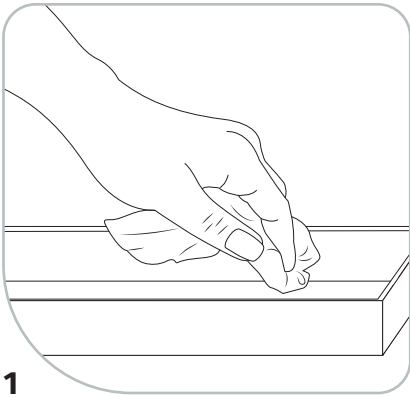

1
Clean and remove all debris from the inside of the channel letter before you begin.

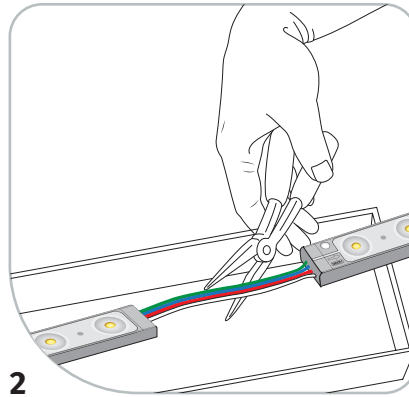

2
Measure and cut LED modules to the appropriate length for each letter. Cuts can be made between any of the modules.

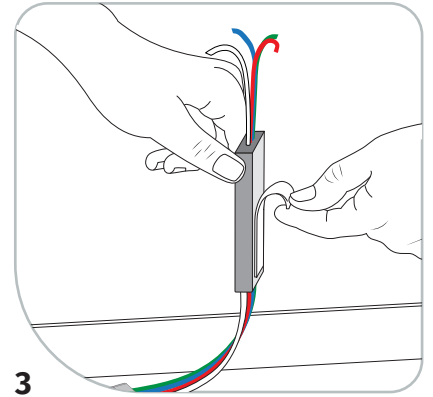

3
Remove tape backing and stick LED modules into place. Continue until you have reached the end of the run.

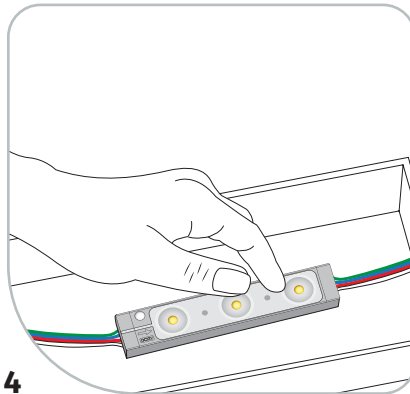

4
Use silicone to secure at least every fifth LED module within the channel letter.

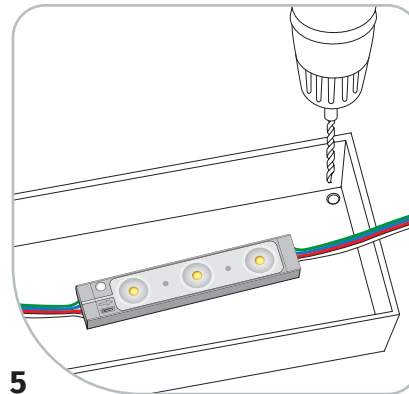

5
Drill a 1/4" hole near the LED strip and grommet the hole for supply wire access.

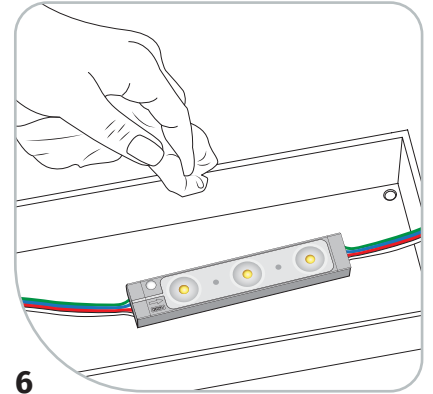

6
Clean and remove all debris from the inside of the channel letter. Replace sign face.



NOTE: For halo-lit applications LED modules should be mounted on UL-recognized clear acrylic or polycarbonate. The light output from the LED system should be directed back into the sign enclosure. This will allow for uniform backlighting of the sign and will provide simple mounting.



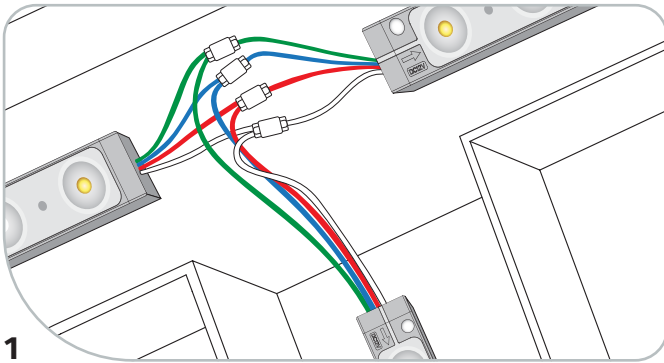

1 Connect LED strips using in-line (IDC) connectors or twist-on wire connectors.

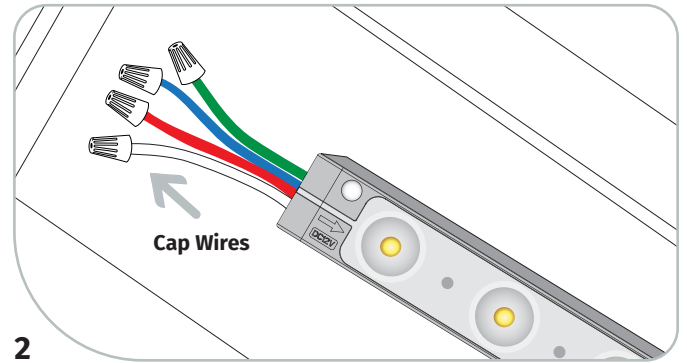

2 Must cap all exposed wires with appropriate wire connectors.

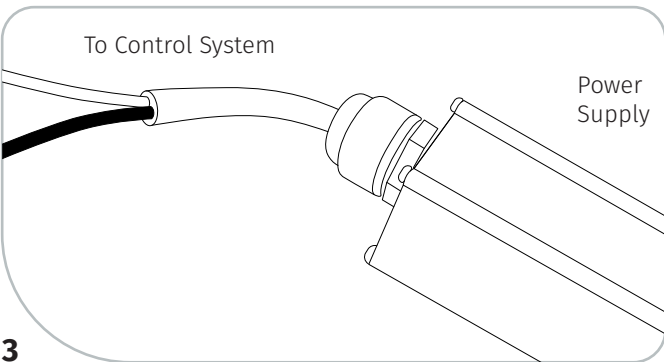

3 Run a wire from the power supply to each controlled component and connect the components to the first LED module on the strip.

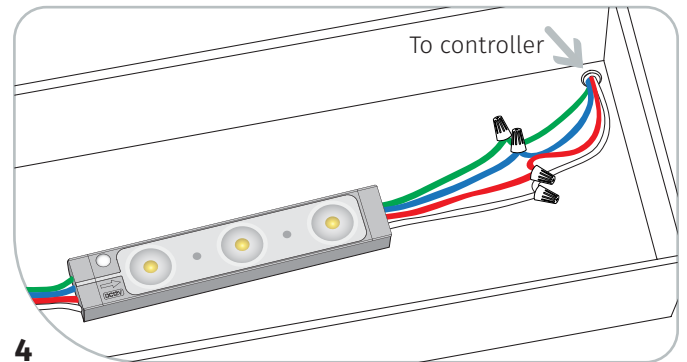

4 Connect each wire (Red, Green, Blue, and Positive) to the labeled (R, G, B, +) on the LED Controller. Make sure that no more than 50 modules are connected to the controller, to ensure that all of the modules are working.



NOTE: All electrical connections should be made within the letter.



The following diagram is provided as an example wiring design. Always review each component installation guide for detailed and up-to-date wiring instructions. Install in accordance with NEC and local regulations.

Yellow (White): + Controller Output
Blue: B Controller Output
Green: G Controller Output
Red: R Controller Output

Attention: When Powering Modules, ensure wires at the opposite end of the run are not in contact. This can cause shorts that may damage the product.

Maximum Recommended Load : 50 modules

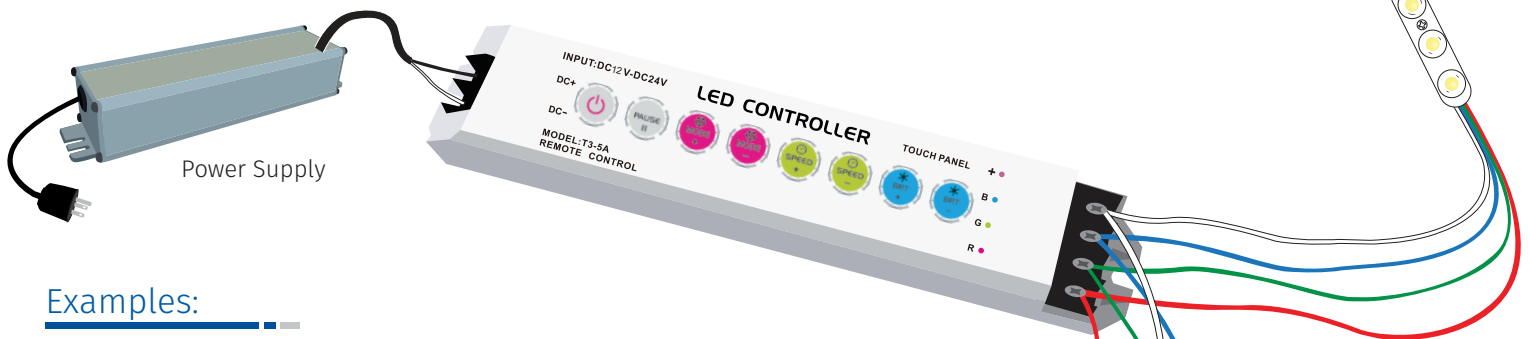

Examples:

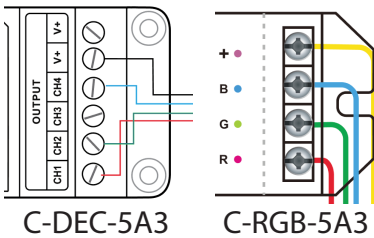

1 Amplifier per additional run of 50 modules

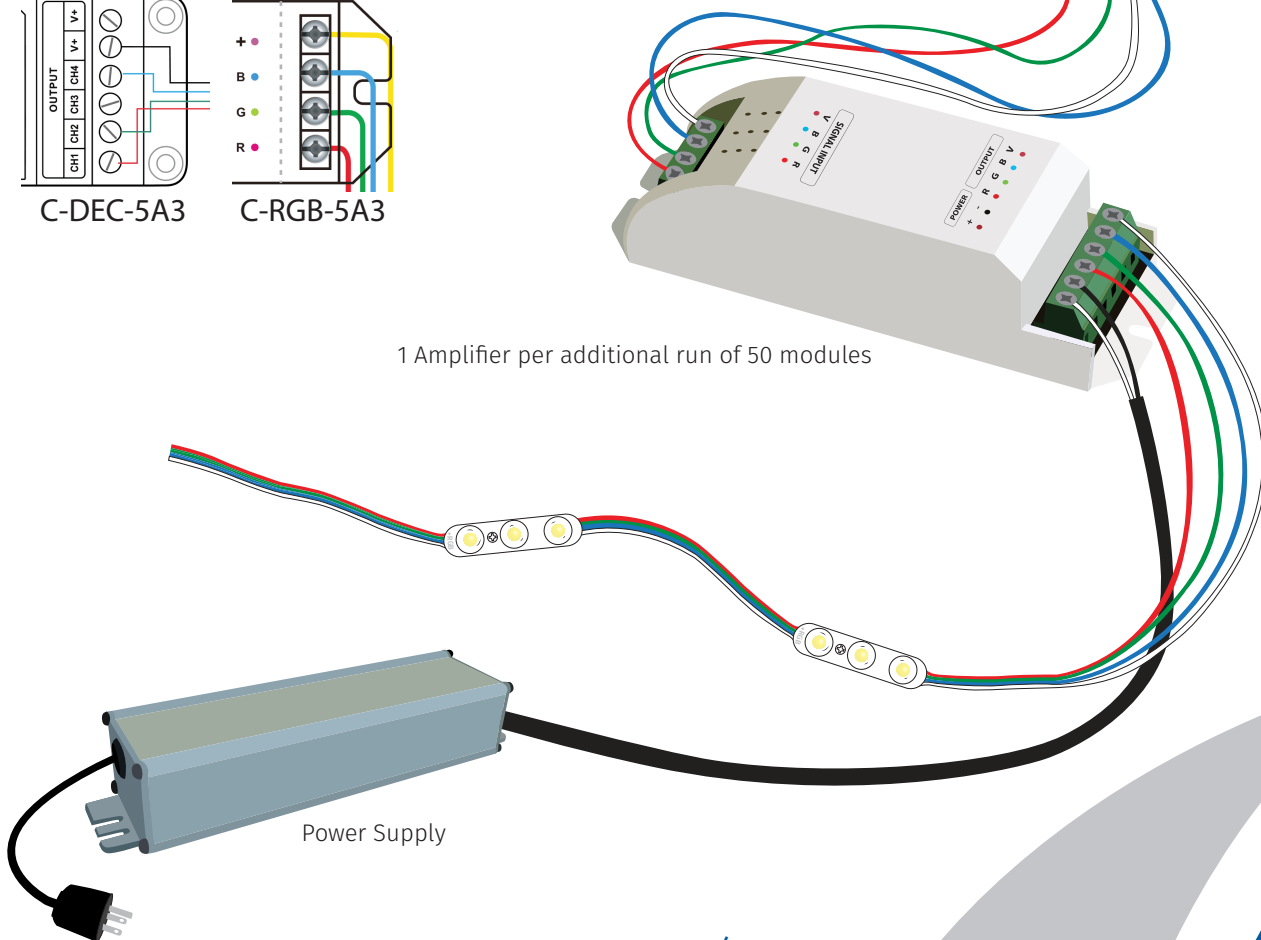

System Diagram

The following diagram is provided as an example system design. Always review each component installation guide for detailed and up-to-date wiring instructions. Install in accordance with NEC and local regulations.



RF 2.4 GHz maximum signal distance 95ft unobstructed

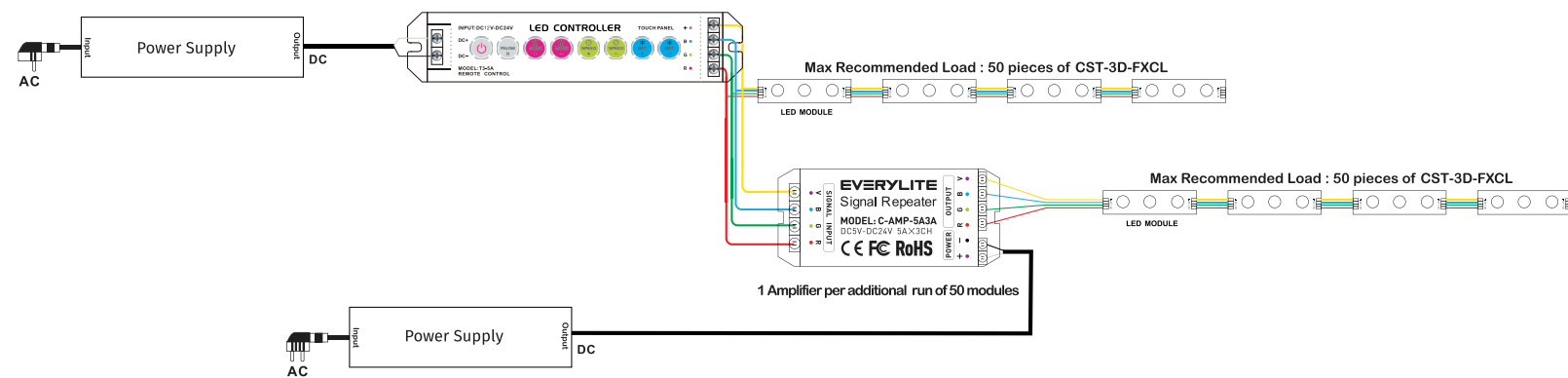

Troubleshooting

Fixture does not illuminate	See 'System Diagram'. Ensure the system is wired correctly and polarities are correct. Ensure a compatible power supply is installed.
Fixture is slowly flashing	Ensure driver is not overloaded. An overloaded driver will cause the internal auto-reset to trip repeatedly.
Some LEDs are not functional	Ensure fixture has not been bent excessively, causing components and solder to detach from circuit board.
Lights are flickering	Ensure no dimmer is installed. If lights continue to flicker, check for loose connections.



HAVE A QUESTION?

Visit www.everylite.com or contact Customer Support at

Tel: 407-250-6706

Fax: 888-567-4532

Toll Free: 1-888-567-4LED (4533)

Monday through Friday, 8:30am - 5:30pm ET.

1936 Premier Row, Orlando, FL 32809